



گروه صنعتی پترو آب حیات کالا

Petro Ab Hayat Kala IND. Group

Address: Unit 12, 2nd Floor, No.2, Mofateh St, Nojumi St, Darvazeh
Dolat St, Tehran, Iran

Tel: +98 (21) 88 32 53 12 -14

Fax: +98 (21) 88 32 53 15

Email: www.aabhayat.kala@gmail.com

Website: www.abhayatkala.com



PE Butt Fusion and Electrofusion Fittings

Product Catalogue

اتصالات الکتروفیوژن و بات
فیوژن پلی اتیلن



اتصالات الکتروفیوژن

Electrofusion fitting



Electrofusion is a type of fitting that can be used in gas and water pipelines. In this connection, the heating method is different from the relatively old welding methods and the electricity is used to generate heat. Using this method, various connections such as pipe-pipe, pipe-elbow, pipe-coupling, etc. can be created. Therefore, the limitation of the butt welding method different to the connection of pipes of the same size does not apply. In addition to its safety, the other advantages of this method are connection speed.

الکتروفیوژن نوعی از اتصالات است که می تواند در خطوط لوله گاز و آب استفاده شود. در این رابطه ، روش گرمایش با روشهای جوشکاری نسبتاً قدیمی متفاوت است و از برق برای تولید گرما استفاده می شود. با استفاده از این روش می توان اتصالات مختلفی مانند لوله ، زانو و غیره ایجاد کرد. بنابراین ، محدودیت روش بات فیوژن در این روش برطرف گشته است. علاوه بر ایمنی ، مزایای دیگر این روش اتصال آسان ، سرعت بالا اتصال است.

Address: Unit 12, 2nd Floor, No.2, Mofateh St, Nojumi St, Darvazeh Dolat St, Tehran, IRAN

Tel: +98 (21) 88 32 53 12
88 32 53 14

Fax: +98 (21) 88 32 53 15

Email: www.aabhayat.kala@gmail.com

Website: www.abhayatkala.com



Electrofusion Tapping Tees

Normal size(mm)	d ₂ (mm)	H(mm)	H ₁ (mm)	L(mm)	L ₁ (mm)	Z(mm)
63×25	32	186	108	165	71	130
63×32	32	186	108	165	76	130
63×40	32	186	108	165	81	137
63×50	32	186	108	165	86	137
63×63	32	134	112	165	100	160
90×25	32	199	121	165	71	130
90×32	32	199	121	165	76	130
90×40	32	199	121	165	81	137
90×50	32	199	121	165	86	137
90×63	32	248	126	165	100	160
110×25	32	209	131	165	71	130
110×32	32	209	131	165	76	130
110×40	32	209	131	165	81	137
110×50	32	209	131	165	86	137
110×63	32	258	136	165	100	160
160×25	32	243	156	165	71	130
160×32	32	243	156	165	76	130
160×40	32	243	156	165	81	137
160×50	32	243	156	165	86	137
160×63	32	283	161	165	100	160
200×25	32	254	176	165	71	130
200×32	32	254	176	165	76	130
200×40	32	254	176	165	81	137
200×50	32	254	176	165	86	137
200×63	32	303	181	165	100	160

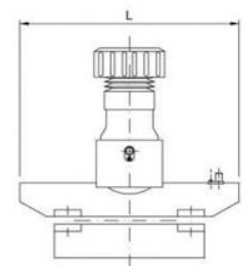
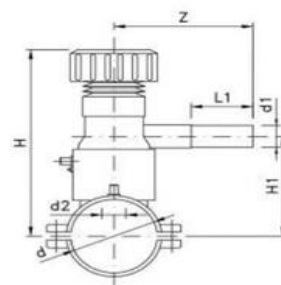

Address: Unit 12, 2nd Floor, No.2, Mofateh St, Nojumi St, Darvazeh Dolat St, Tehran, IRAN

Tel: +98 (21) 88 32 53 12

88 32 53 14

Fax: +98 (21) 88 32 53 15

Email: www.aabhayat.kala@gmail.com

Website: www.abhayatkala.com



کوپلر الکتروفیوژن

Electrofusion Coupler

Normal size(mm)	L(mm)	f(mm)	z(mm)
20	41	10	82
25	41	10	82
32	44	10	88
40	49	10	98
50	55	10	110
63	47	17	95
75	53	21	106
90	61	29	123
110	72	36	144
125	78	39	157
160	89	51	178
180	103	57	206
200	103	57	206
225	112	62	224
250	117	61	234
315	126	71	253
355	170	100	340
400	190	120	380

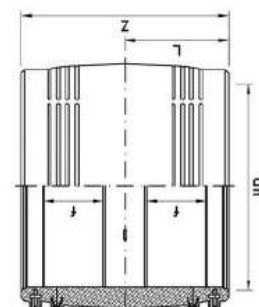

Address: Unit 12, 2nd Floor, No.2, Mofateh St, Nojumi St, Darvazeh Dolat St, Tehran, IRAN

Tel: +98 (21) 88 32 53 12

88 32 53 14

Fax: +98 (21) 88 32 53 15

Email: www.aabhayat.kala@gmail.com

Website: www.abhayatkala.com



سه راه مساوی و نامساوی الکتروفیوژن

Electrofusion Equal and Reduced

Normal size(mm)	Z(mm)	Z ₁ (mm)	L ₁ (mm)
63×63	158	114	69
75×63	213	154	92
75×75	213	154	92
90×63	213	154	92
90×75	213	154	92
90×90	213	154	92
110×63	256	191	114
110×75	256	191	114
110×90	256	191	114
110×110	256	191	114
160×63	337	170	69
160×75	337	170	69
160×90	337	193	92
160×110	337	215	114
160×160	337	213	108
200×63	420	197	69
200×75	420	197	69
200×90	420	220	92
200×110	420	242	114
200×200	420	259	125

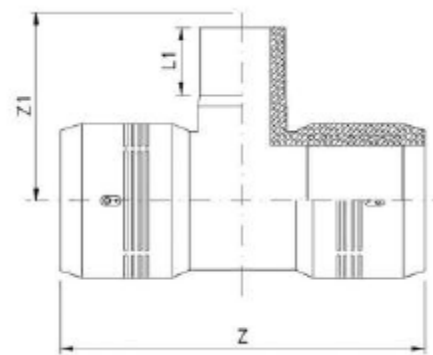

Address: Unit 12, 2nd Floor, No.2, Mofateh St, Nojumi St, Darvazeh Dolat St, Tehran, IRAN

Tel: +98 (21) 88 32 53 12
88 32 53 14

Fax: +98 (21) 88 32 53 15

Email: www.aabhayat.kala@gmail.com

Website: www.abhayatkala.com



Electrofusion 90 Degree Elbows

Normal size(mm)	Z(mm)	L (mm)
63	80	46
75	100	52
90	117	62
110	140	72
125	170	78
160	190	92
200	220	104

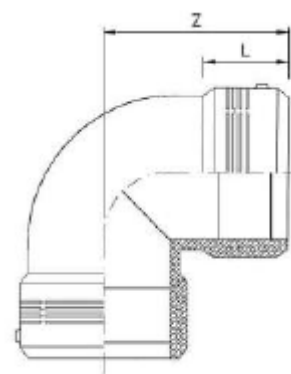

Address: Unit 12, 2nd Floor, No.2, Mofateh St, Nojumi St, Darvazeh Dolat St, Tehran, IRAN

Tel: +98 (21) 88 32 53 12

88 32 53 14

Fax: +98 (21) 88 32 53 15

Email: www.aabhayat.kala@gmail.com

Website: www.abhayatkala.com



Electrofusion Equal Tee

Normal size(mm)	Z(mm)	Z ₁ (mm)	L ₁ (mm)	L (mm)
40	250	96	38	49
50	318	106	59	55
63	316	115	66	47
75	350	129	71	52
90	393	143	70	61
110	460	167	85	71
125	491	168	90	78
160	576	200	101	88
200	648	239	108	100
225	674	262	102	110
250	747	282	100	115
315	855	323	92	130
355	990	326	125	170
400	1025	325	125	190

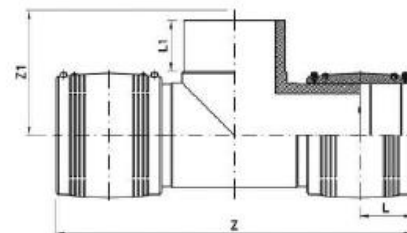

Address: Unit 12, 2nd Floor, No.2, Mofateh St, Nojumi St, Darvazeh Dolat St, Tehran, IRAN

Tel: +98 (21) 88 32 53 12
88 32 53 14

Fax: +98 (21) 88 32 53 15

Email: www.aabhayat.kala@gmail.com

Website: www.abhayatkala.com



Electrofusion Reduced Tee

Normal size(mm)	Z(mm)	Z ₁ (mm)	L ₁ (mm)	L (mm)
63×50	311	105	63	47
75×50	355	133	63	53
75×63	354	126	66	53
90×63	393	133	67	61
90×75	389	128	70	61
110×63	460	168	66	71
110×75	492	159	72	71
110×90	460	155	80	71
125×63	492	166	66	78
125×75	491	167	71	78
125×90	488	163	81	78
160×63	557	198	67	88
160×75	584	197	67	88
160×90	576	202	85	88
160×110	655	205	90	88
200×75	574	195	75	103
200×90	674	227	83	103
200×110	674	201	87	103
200×160	674	262	83	103
225×63	674	262	102	110
225×90	674	262	102	110
225×110	674	262	102	110
225×160	674	204	102	110
250×90	581	220	88	102
250×110	640	220	72	100
250×160	648	228	83	100
250×200	635	215	79	100

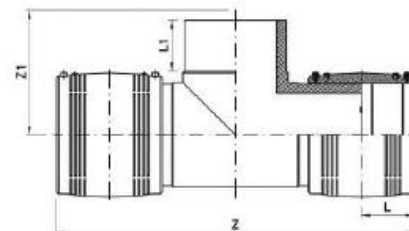

Address: Unit 12, 2nd Floor, No.2, Mofateh St, Nojumi St, Darvazeh Dolat St, Tehran, IRAN

Tel: +98 (21) 88 32 53 12
88 32 53 14

Fax: +98 (21) 88 32 53 15

Email: www.aabhayat.kala@gmail.com

Website: www.abhayatkala.com



Electrofusion 90 Degree Elbows

Normal size(mm)	Z(mm)	L (mm)
40	129	49
50	165	55
63	159	47
75	172	52
90	188	61
110	224	71
125	250	78
160	288	88
200	348	100
225	353	110
250	365	115
315	459	130
355	498	170
400	515	190

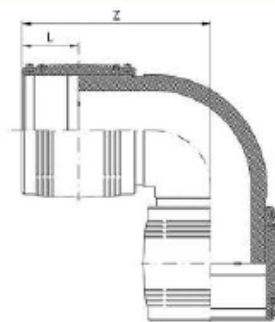

Address: Unit 12, 2nd Floor, No.2, Mofateh St, Nojumi St, Darvazeh Dolat St, Tehran, IRAN

Tel: +98 (21) 88 32 53 12
88 32 53 14

Fax: +98 (21) 88 32 53 15

Email: www.aabhayat.kala@gmail.com

Website: www.abhayatkala.com



Electrofusion 45 Degree Elbows

Normal size(mm)	Z(mm)	L (mm)
40	129	49
50	165	55
63	141	47
75	157	52
90	181	61
110	192	71
125	208	78
160	236	88
200	280	100
225	294	110
250	325	115
315	336	130
400	417	190

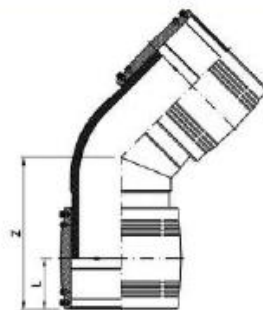

Address: Unit 12, 2nd Floor, No.2, Mofateh St, Nojumi St, Darvazeh Dolat St, Tehran, IRAN

Tel: +98 (21) 88 32 53 12

88 32 53 14

Fax: +98 (21) 88 32 53 15

Email: www.aabhayat.kala@gmail.com

Website: www.abhayatkala.com



Electrofusion Reducers

Normal Size(mm)	Lt(mm)	L ₁ (mm)	L ₂ (mm)
63×40	229	49	47
63×50	233	55	47
75×40	250	49	53
75×50	256	55	53
75×63	243	47	52
90×63	247	47	61
90×75	265	52	61
110×63	286	47	71
110×75	290	52	71
110×90	299	61	71
125×63	283	47	78
125×90	349	61	78
125×110	300	71	78
160×63	347	47	88
160×75	353	53	88
160×90	361	61	88
160×110	386	71	88
160×125	381	78	88
200×63	413	47	103
200×75	419	53	103
200×90	427	61	103
200×110	419	71	103
200×125	428	78	103
200×160	471	88	103

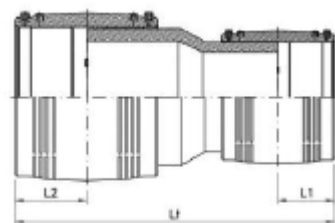

Address: Unit 12, 2nd Floor, No.2, Mofateh St, Nojumi St, Darvazeh Dolat St, Tehran, IRAN

Tel: +98 (21) 88 32 53 12
88 32 53 14

Fax: +98 (21) 88 32 53 15

Email: www.aabhayat.kala@gmail.com

Website: www.abhayatkala.com



Electrofusion Reducers

تبدیل الکتروفیوژن

Normal size(mm)	Lt(mm)	L ₁ (mm)	L ₂ (mm)
225×63	492	47	112
225×75	492	52	112
225×90	492	61	112
225×110	492	71	112
225×125	492	78	112
225×160	492	88	112
225×200	492	103	112
250×90	463	61	117
250×110	471	71	115
250×160	497	88	115
250×200	502	100	115
315×160	700	88	126
315×200	619	103	126
315×250	633	117	126
400×160	734	89	190
400×200	763	103	190

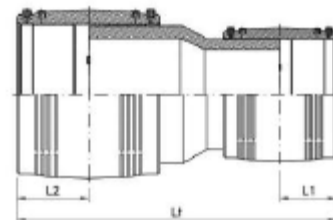

Address: Unit 12, 2nd Floor, No.2, Mofateh St, Nojumi St, Darvazeh Dolat St, Tehran, IRAN

Tel: +98 (21) 88 32 53 12
88 32 53 14

Fax: +98 (21) 88 32 53 15

Email: www.aabhayat.kala@gmail.com

Website: www.abhayatkala.com



Electrofusion Cap

Normal size(mm)	Z(mm)	L (mm)
40	111	49
50	118	55
63	112	47
75	130	52
90	149	61
110	162	71
125	178	78
160	210	88
200	235	100
225	278	112
250	252	117
315	376	126
355	420	170
400	440	190

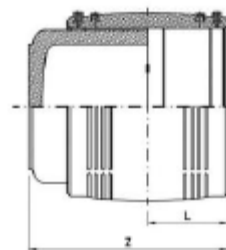

Address: Unit 12, 2nd Floor, No.2, Mofateh St, Nojumi St, Darvazeh Dolat St, Tehran, IRAN

Tel: +98 (21) 88 32 53 12
88 32 53 14

Fax: +98 (21) 88 32 53 15

Email: www.aabhayat.kala@gmail.com

Website: www.abhayatkala.com



اتصالات بات فیوژن

Butt Fusion fitting



بات فیوژن یکی از مهمترین انواع جوشکاری لوله های پلاستیکی است که از استحکام بالایی برخوردار بوده و تا قطر ۲۴۰۰ میلی متر قابل انجام است. این روش در اتصال لوله های فولادی نیز از اهمیت بالایی برخوردار است. محدودیت این روش این است که لوله های کاملاً مشابه از نظر نوع ، قطر و ضخامت را می توان بهم جوش داد. از این نوع این روش اتصال مطابق استاندارد DVS2212-1 تولید می شود.

Butt weld is one of the most important types of plastic pipe welding that is high strength and up to a diameter of 2400 mm can be done. This method of connecting steel pipes is also of high relevance. The limitation of this method is that only the completely similar pipes in terms of type, diameter, and thickness can be welded. Of this kind this connection method is done according to DVS2212-1 Standard.



Address: Unit 12, 2nd Floor, No.2, Mofateh St, Nojumi St, Darvazeh Dolat St, Tehran, IRAN

Tel: +98 (21) 88 32 53 12

88 32 53 14

Fax: +98 (21) 88 32 53 15

Email: www.aabhayat.kala@gmail.com

Website: www.abhayatkala.com



فلنج

Flange Adaptor (Type A)

Normal size(mm)	d ₂ (mm)	d ₃ (mm)	Z(mm) Normal	Z(mm) Long
32	68	40	-	85
40	78	50	-	85
50	88	61	-	85
63	102	75	92	95
75	122	89	110	120
90	138	105	125	140
110	158	125	120	160
125	158	132	120	170
140	188	155	152	200
160	212	175	155	200
180	212	180	171	199
200	268	232	193	199
225	268	235	200	200
250	320	285	204	204
280	320	291	171	210
315	370	335	173	210
355	430	373	181	210
400	482	427	150	-
450	585	514	150	-
500	585	530	150	-
560	685	615	150	-
630	685	642	250	-
710	800	737	250	-
800	905	840	270	-
900	1005	944	280	-
1000	1110	1047	290	-

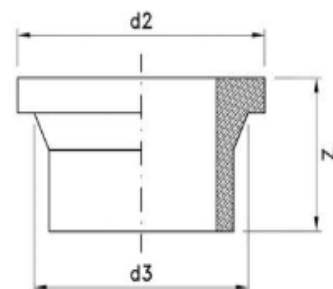

Address: Unit 12, 2nd Floor, No.2, Mofateh St, Nojumi St, Darvazeh Dolat St, Tehran, IRAN

Tel: +98 (21) 88 32 53 12
88 32 53 14

Fax: +98 (21) 88 32 53 15

Email: www.aabhayat.kala@gmail.com

Website: www.abhayatkala.com

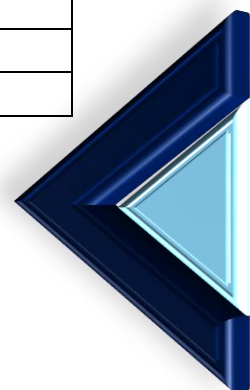

فلنج

Flange Adaptor (Type B)

Normal size(mm)	d ₂ (mm)	d ₃ (mm)	d ₄ (mm)	Z(mm) Normal	Z(mm) Long
63	102	75	60	92	95
75	122	89	66	110	120
90	138	105	78	125	140
110	158	125	100	120	160
125	158	132	114	120	170
140	188	155	127	152	200
160	212	175	151	155	200
180	212	180	158	171	199
200	268	232	203	193	199
225	268	235	210	200	200
250	320	285	245	204	204
280	320	291	265	171	210
315	370	335	300	173	210
355	430	373	-	181	210
400	482	427	-	150	-
450	585	514	-	150	-
500	585	530	-	150	-

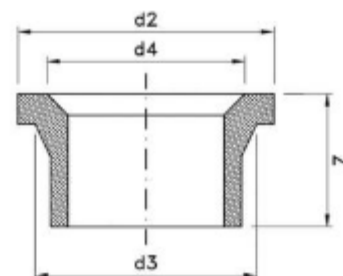

Address: Unit 12, 2nd Floor, No.2, Mofateh St, Nojumi St, Darvazeh Dolat St, Tehran, IRAN

Tel: +98 (21) 88 32 53 12
88 32 53 14

Fax: +98 (21) 88 32 53 15

Email: www.aabhayat.kala@gmail.com

Website: www.abhayatkala.com



Equal Tee 90 Degree

Normal size(mm)	Z(mm)	Z ₁ (mm)	L (mm)
32	133	81	28
40	151	96	38
50	208	108	59
63	221	106	60
75	248	124	72
90	247	136	70
110	317	159	85
125	290	147	67
140	375	194	35
160	400	200	102
180	466	234	107
200	450	239	108
225	454	262	102
250	517	282	101
280	601	324	101
315	596	299	125
355	651	326	125
400	645	325	125
450	970	511	201
500	970	511	201

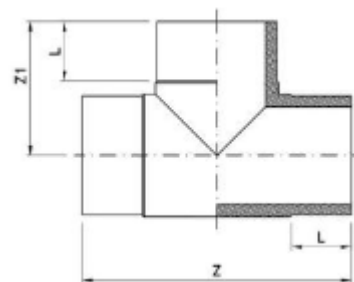

Address: Unit 12, 2nd Floor, No.2, Mofateh St, Nojumi St, Darvazeh Dolat St, Tehran, IRAN

Tel: +98 (21) 88 32 53 12
88 32 53 14

Fax: +98 (21) 88 32 53 15

Email: www.aabhayat.kala@gmail.com

Website: www.abhayatkala.com



Reduced Tee 90 Degree

Normal Size(mm)	L ₁ (mm)	L ₂ (mm)	Z ₁ (mm)	Z ₂ (mm)
63×32	65	49	216	105
63×40	65	49	216	105
63×50	67	63	216	105
75×40	73	50	249	119
75×50	71	63	250	133
75×63	72	65	245	120
90×50	71	66	275	131
90×63	72	67	271	128
90×75	69	70	267	168
110×50	86	65	318	157
110×63	87	67	318	168
110×75	81	72	320	159
110×90	86	80	319	156
125×50	90	72	337	167
125×63	90	65	340	165
125×75	89	66	337	167
125×90	89	81	332	163
125×110	91	82	341	169
140×75	83	90	380	185
140×90	83	90	380	185
140×110	85	90	380	187
140×125	85	90	380	187

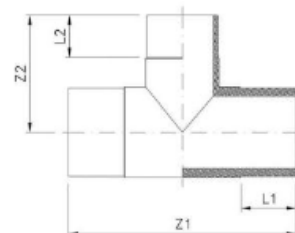

Address: Unit 12, 2nd Floor, No.2, Mofateh St, Nojumi St, Darvazeh Dolat St, Tehran, IRAN

Tel: +98 (21) 88 32 53 12
88 32 53 14

Fax: +98 (21) 88 32 53 15

Email: www.aabhayat.kala@gmail.com

Website: www.abhayatkala.com



Reduced Tee 90 Degree

Normal Size(mm)	L ₁ (mm)	L ₂ (mm)	Z ₁ (mm)	Z ₂ (mm)
160×63	102	67	406	198
160×75	98	76	402	196
160×90	102	85	399	202
160×110	104	90	406	205
160×125	103	92	407	201
180×63	108	51	445	207
180×90	108	53	428	260
180×110	110	82	440	217
180×160	105	105	440	214
200×63	116	75	440	225
200×75	116	72	443	290
200×90	118	83	450	227
200×110	116	87	448	225
200×125	117	91	450	228
200×160	116	102	405	225
225×63	120	110	530	260
225×75	120	110	530	260
225×90	120	110	530	260
225×110	120	110	530	260
225×125	120	110	530	260
225×160	120	110	530	260
250×63	101	90	518	355
250×90	102	79	519	263
250×110	104	82	520	262
250×125	100	90	515	270
250×160	102	99	523	265
250×200	105	116	515	268

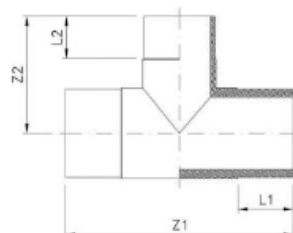

Address: Unit 12, 2nd Floor, No.2, Mofateh St, Nojumi St, Darvazeh Dolat St, Tehran, IRAN

Tel: +98 (21) 88 32 53 12
88 32 53 14

Fax: +98 (21) 88 32 53 15

Email: www.aabhayat.kala@gmail.com

Website: www.abhayatkala.com



Reduced Tee 90 Degree

Normal Size(mm)	L ₁ (mm)	L ₂ (mm)	Z ₁ (mm)	Z ₂ (mm)
315×90	92	93	596	296
315×110	118	137	590	302
315×125	92	92	595	296
315×160	93	90	590	287
315×200	91	93	600	300
315×225	91	90	600	290
315×250	117	94	595	300
355×90	119	87	646	278
355×110	120	88	647	280
355×125	119	102	648	286
355×160	118	114	650	308
355×200	119	117	645	332
355×225	119	116	645	333
355×250	120	115	645	332
400×160	101	103	645	324
400×200	115	103	645	327
400×250	113	100	670	330
400×315	120	112	670	350
500×200	122	123	788	401
500×225	123	114	770	389
500×250	120	115	780	390
500×315	118	118	770	315

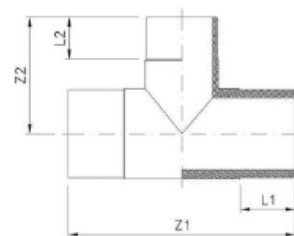

Address: Unit 12, 2nd Floor, No.2, Mofateh St, Nojumi St, Darvazeh Dolat St, Tehran, IRAN

Tel: +98 (21) 88 32 53 12
88 32 53 14

Fax: +98 (21) 88 32 53 15

Email: www.aabhayat.kala@gmail.com

Website: www.abhayatkala.com



Molded Butt Fusion 90 Degree

Normal size(mm)	Z(mm)	L (mm)
32	72	45
40	80	50
50	110	63
63	117	61
75	120	60.3
90	128	54.9
110	158	86
125	172	85
140	174	87
160	179	102
180	247	129
200	244	120
225	242	113
250	248	103
315	327	122
355	328	123
400	325	122
450	382	123
500	381	122

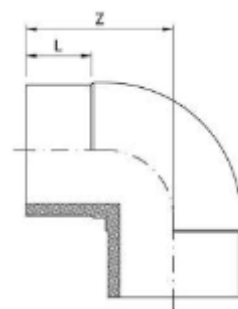

Address: Unit 12, 2nd Floor, No.2, Mofateh St, Nojumi St, Darvazeh Dolat St, Tehran, IRAN

Tel: +98 (21) 88 32 53 12

88 32 53 14

Fax: +98 (21) 88 32 53 15

Email: www.aabhayat.kala@gmail.com

Website: www.abhayatkala.com



Molded Butt Fusion 45 Degree

زانو ۴۵ درجه بات فیوژن

Normal size(mm)	Z(mm)	L (mm)
40	80	49
50	110	60
63	92	57
75	97	60
90	102	78
110	118	84
125	125	88
160	138	86
180	149	106
200	179	117
225	184	111
250	210	128
315	206	120
400	227	120

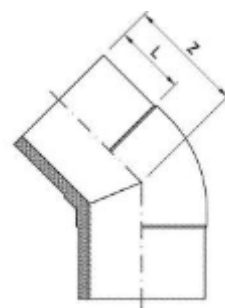

Address: Unit 12, 2nd Floor, No.2, Mofateh St, Nojumi St, Darvazeh Dolat St, Tehran, IRAN

Tel: +98 (21) 88 32 53 12
88 32 53 14

Fax: +98 (21) 88 32 53 15

Email: www.aabhayat.kala@gmail.com

Website: www.abhayatkala.com



Molded Butt Fusion 11.25 , 22.5 , 30 Degree

Normal size	Z _{min} (mm)	L (mm)
40	90	58
50	90	58
63	95	60
75	110	79
90	65	85
110	130	88
125	140	85
160	160	106
180	170	117
200	185	111
225	200	128
250	230	102
315	210	120
355	220	115
400	210	118

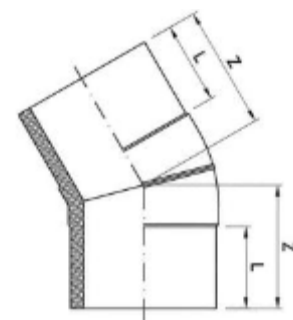

Address: Unit 12, 2nd Floor, No.2, Mofateh St, Nojumi St, Darvazeh Dolat St, Tehran, IRAN

Tel: +98 (21) 88 32 53 12

88 32 53 14

Fax: +98 (21) 88 32 53 15

Email: www.aabhayat.kala@gmail.com

Website: www.abhayatkala.com



Concentric Reducer Long Spigot

Normal size(mm)	Lt(mm)	L (mm)	L ₁ (mm)
32×20	118	41	45
32×25	118	41	45
40×25	118	41	45
40×32	125	50	45
50×25	134	59	48
50×32	125	58	48
50×40	129	62	51
63×20	131	61	30
63×25	132	61	43
63×32	142	60	40
63×40	133	57	49
63×50	131	55	56
75×40	148	67	46
75×50	148	66	55
75×63	143	67	58
90×63	139	71	51
90×75	151	69	64
110×20	151	77	41
110×32	155	78	42
110×63	167	77	54
110×75	167	82	64
110×90	210	91	64
125×63	158	85	54
125×75	214	91	77
125×90	214	91	77
125×110	152	74	63

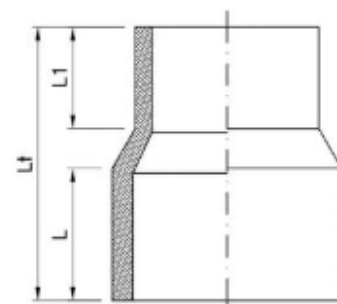

Address: Unit 12, 2nd Floor, No.2, Mofateh St, Nojumi St, Darvazeh Dolat St, Tehran, IRAN

Tel: +98 (21) 88 32 53 12

88 32 53 14

Fax: +98 (21) 88 32 53 15

Email: www.aabhayat.kala@gmail.com

Website: www.abhayatkala.com



Concentric Reducer Long Spigot

Normal size(mm)	Lt(mm)	L (mm)	L ₁ (mm)
160×63	212	76	87
160×75	212	76	87
160×90	212	76	87
160×110	151	101	83
160×125	227	94	70
180×90	236	95	70
180×110	264	112	86
180×125	265	112	86
180×140	285	133	87
180×160	245	112	79
200×63	263	112	82
200×75	263	112	82
200×90	263	112	82
200×110	260	114	88
200×125	248	101	88
200×140	285	133	88
200×160	285	133	88
200×180	285	133	88
225×63	287	115	80
225×75	287	115	80
225×90	287	115	80
225×110	287	115	80
225×125	287	115	80
225×140	287	115	80

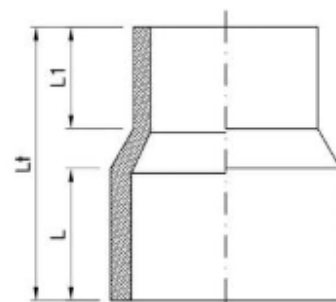

Address: Unit 12, 2nd Floor, No.2, Mofateh St, Nojumi St, Darvazeh Dolat St, Tehran, IRAN

Tel: +98 (21) 88 32 53 12
88 32 53 14

Fax: +98 (21) 88 32 53 15

Email: www.aabhayat.kala@gmail.com

Website: www.abhayatkala.com



Concentric Reducer Long Spigot

Normal size	L ₁ (mm)	L (mm)	L ₁ (mm)
225×160	287	115	80
225×180	286	142	91
225×200	286	142	91
250×90	285	120	85
250×110	285	120	85
250×160	287	115	80
250×180	299	126	96
250×200	286	142	91
315×160	486	150	95
315×200	390	154	96
315×250	390	154	96
355×250	260	95	120
355×315	260	95	120
400×160	470	190	105
400×200	470	190	110
400×250	470	190	117
400×315	470	190	126
450×315	325	120	120
450×355	325	120	120
450×400	325	120	120
500×355	325	120	120
500×400	325	120	120
500×450	400	101	101
560×400	400	101	101
630×400	400	101	101
630×500	400	101	101
630×560	400	101	101

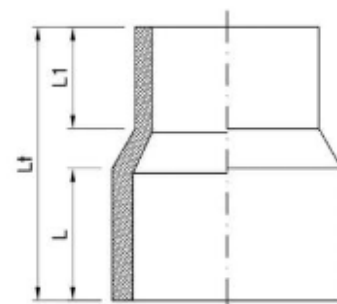

Address: Unit 12, 2nd Floor, No.2, Mofateh St, Nojumi St, Darvazeh Dolat St, Tehran, IRAN

Tel: +98 (21) 88 32 53 12

88 32 53 14

Fax: +98 (21) 88 32 53 15

Email: www.aabhayat.kala@gmail.com

Website: www.abhayatkala.com



STEPPED REDUCER SHORT

Nominal Size(mm)	Sub Dimension	L ₁ (mm)	L ₂ (mm)	L _t (mm)	L (mm)
140×75	90×75	25	17	54	201
	110×90	30	25	80	
	110×75	30	17	116	
	125×75	30	30	155	
	125×90	30	25	135	
	125×110	30	30	72	
	140×75	31	17	201	
	140×90	31	25	172	
	140×110	31	30	120	
	140×125	31	30	75	
200×110	125×110	25	25	56	220
	160×110	35	25	121	
	160×125	35	25	70	
	180×110	31	25	165	
	180×125	31	25	100	
	180×160	31	35	78	
	200×110	36	25	220	
	200×125	36	25	111	
	200×160	36	35	145	
	200×180	36	31	94	

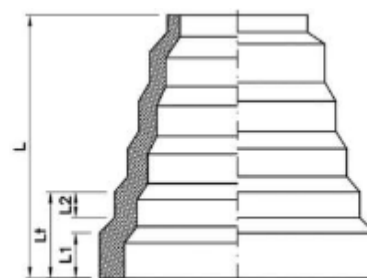

Address: Unit 12, 2nd Floor, No.2, Mofateh St, Nojumi St, Darvazeh Dolat St, Tehran, IRAN

Tel: +98 (21) 88 32 53 12

88 32 53 14

Fax: +98 (21) 88 32 53 15

Email: www.aabhayat.kala@gmail.com

Website: www.abhayatkala.com



Concentric Reducer Short Spigot

Nominal Size(mm)	Sub Dimension	L ₁ (mm)	L ₂ (mm)	L _t (mm)	L (mm)
315×160	200×160	29	30	80	265
	225×160	29	30	121	
	225×200	28	29	70	
	250×160	30	30	158	
	250×200	30	29	108	
	250×225	30	28	70	
	280×160	28	30	201	
	280×200	28	29	146	
	280×225	28	28	109	
	280×250	28	30	68	
	315×160	47	30	265	
	315×200	47	29	212	
	315×225	47	28	172	
	315×250	47	30	131	
400×200	225×200	41	31	64	395
	250×200	40	31	148	
	250×200	40	41	98	
	315×200	39	31	240	
	315×225	39	41	188	
	315×250	39	40	129	
	355×200	39	31	307	
	355×225	39	41	257	
	355×250	39	40	198	
	355×315	39	39	109	
	400×200	63	31	395	
	400×225	63	41	350	
	400×250	63	40	290	
	400×315	63	39	200	
400×355	63	39	132		

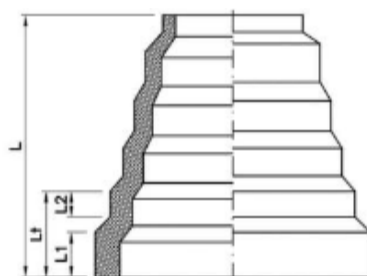

Address: Unit 12, 2nd Floor, No.2, Mofateh St, Nojumi St, Darvazeh Dolat St, Tehran, IRAN

Tel: +98 (21) 88 32 53 12

88 32 53 14

Fax: +98 (21) 88 32 53 15

Email: www.aabhayat.kala@gmail.com

Website: www.abhayatkala.com

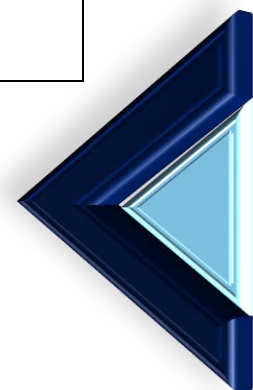

Eccentric Reducer

Normal size(mm)	L ₁ (mm)	L ₂ (mm)	L _t (mm)
90×50	50	35	150
90×63	50	35	150
90×75	50	35	150
110×50	50	35	150
110×63	50	35	150
110×75	50	35	150
110×90	50	35	150
125×63	50	35	150
125×75	50	35	150
125×90	50	35	150
125×110	50	35	150
160×90	50	35	180
160×110	50	35	180
160×125	50	35	180
160×140	50	35	180
180×90	50	35	180
180×110	50	35	180
180×125	50	35	180
180×140	50	35	180
180×160	50	35	180
200×110	50	40	185
200×125	50	40	185
200×140	50	40	185
200×160	50	40	185
200×180	50	40	185
225×110	50	40	185
225×125	50	40	185

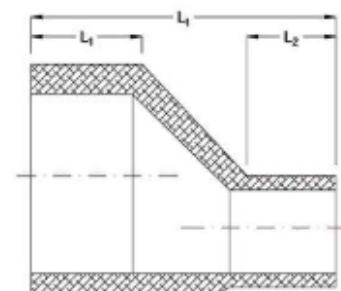

Address: Unit 12, 2nd Floor, No.2, Mofateh St, Nojumi St, Darvazeh Dolat St, Tehran, IRAN

Tel: +98 (21) 88 32 53 12

88 32 53 14

Fax: +98 (21) 88 32 53 15

Email: www.aabhayat.kala@gmail.com

Website: www.abhayatkala.com



Eccentric Reducer

Normal size(mm)	L ₁ (mm)	L ₂ (mm)	L _t (mm)
225×140	50	40	185
225×160	50	40	185
225×180	50	40	185
225×200	50	40	185
250×140	50	40	185
250×160	50	40	205
250×180	50	40	205
250×200	50	40	205
250×225	50	40	205
315×200	50	40	220
315×225	50	40	220
315×250	50	40	220
355×200	50	40	220
355×250	50	40	220
355×315	50	40	220
400×200	50	40	220
400×225	50	40	220
400×250	50	40	220
400×315	50	40	220
400×355	50	40	220

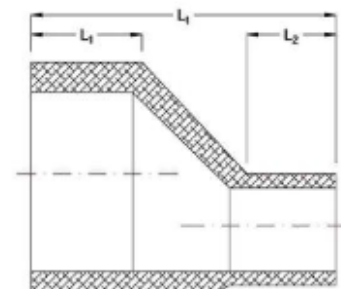

Address: Unit 12, 2nd Floor, No.2, Mofateh St, Nojumi St, Darvazeh Dolat St, Tehran, IRAN

Tel: +98 (21) 88 32 53 12
88 32 53 14

Fax: +98 (21) 88 32 53 15

Email: www.aabhayat.kala@gmail.com

Website: www.abhayatkala.com



Molded Butt Fusion Caps

Normal size(mm)	Z(mm)	L (mm)
32	50	40
40	62	57
50	63	57
63	64	52
75	65	57
90	78	65
110	88	68
125	91	79
160	100	88
200	166	114
225	166	114
250	135	120
280	195	170
315	250	150
355	250	150
400	250	150
450	260	100
500	480	100
560	680	100
630	720	115

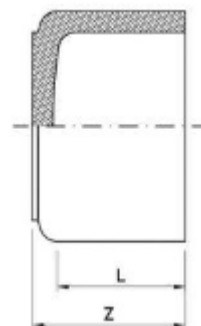

Address: Unit 12, 2nd Floor, No.2, Mofateh St, Nojumi St, Darvazeh Dolat St, Tehran, IRAN

Tel: +98 (21) 88 32 53 12
88 32 53 14

Fax: +98 (21) 88 32 53 15

Email: www.aabhayat.kala@gmail.com

Website: www.abhayatkala.com



Cross

Normal size(mm)	Z _k (mm)	L _e (mm)
63	106	60
75	124	72
90	136	70
110	165	85
160	206	101
200	246	118
250	303	144
315	299	125
355	325	125
400	325	125

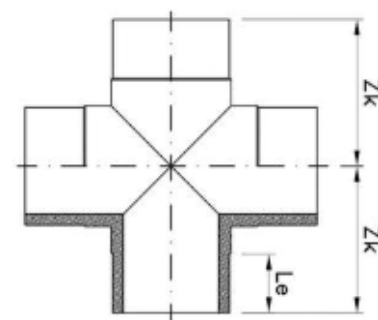

Address: Unit 12, 2nd Floor, No.2, Mofateh St, Nojumi St, Darvazeh Dolat St, Tehran, IRAN

Tel: +98 (21) 88 32 53 12
88 32 53 14

Fax: +98 (21) 88 32 53 15

Email: www.aabhayat.kala@gmail.com

Website: www.abhayatkala.com



خم ۹۰ درجه

90 Degree Sweep Bend

Size (mm)	A(mm)	B(mm)	R(mm)
20	200	100	100
25	200	100	100
32	228	100	128
40	260	100	160
50	275	100	175
63	325	100	225
75	455	150	305
90	455	150	305
110	560	180	380
125	560	180	380
140	660	200	460
160	660	200	460
200	785	250	535
225	785	250	535
250	915	300	615
280	965	350	615
315	1115	400	715
355	1280	500	780
400	1620	550	1070
450	1650	550	1100
500	1950	700	1250
560	1982	700	1250
630	2015	700	1282

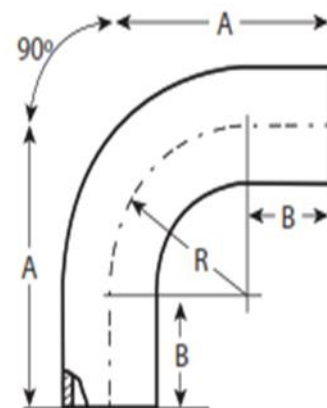

Address: Unit 12, 2nd Floor, No.2, Mofateh St, Nojumi St, Darvazeh Dolat St, Tehran, IRAN

Tel: +98 (21) 88 32 53 12

88 32 53 14

Fax: +98 (21) 88 32 53 15

Email: www.aabhayat.kala@gmail.com

Website: www.abhayatkala.com



60 Degree Sweep Bend

Size (mm)	A(mm)	B(mm)	R(mm)
20	155	100	100
25	155	100	100
32	170	100	128
40	190	100	160
50	200	100	175
63	230	100	225
75	320	150	305
90	320	150	305
110	400	180	380
125	400	180	380
140	465	200	460
160	465	200	460
200	560	250	535
225	560	250	535
250	655	300	615
280	705	350	615
315	810	400	715
355	950	500	780
400	1160	550	1070
450	1185	550	1100
500	1420	700	1250
560	1440	700	1280
630	1460	700	1315

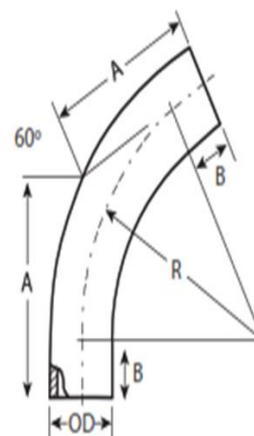

Address: Unit 12, 2nd Floor, No.2, Mofateh St, Nojumi St, Darvazeh Dolat St, Tehran, IRAN

Tel: +98 (21) 88 32 53 12

88 32 53 14

Fax: +98 (21) 88 32 53 15

Email: www.aabhayat.kala@gmail.com

Website: www.abhayatkala.com



45 Degree Sweep Bend

Size (mm)	A(mm)	B(mm)	R(mm)
20	140	100	100
25	140	100	100
32	150	100	128
40	165	100	160
50	170	100	175
63	190	100	225
75	270	150	305
90	270	150	305
110	340	180	380
125	340	180	380
140	390	200	460
160	390	200	460
200	470	250	535
225	470	250	535
250	550	300	615
280	605	350	615
315	695	400	715
355	820	500	780
400	990	550	1070
450	1005	550	1100
500	1215	700	1250
560	1230	700	1280
630	1245	700	1315

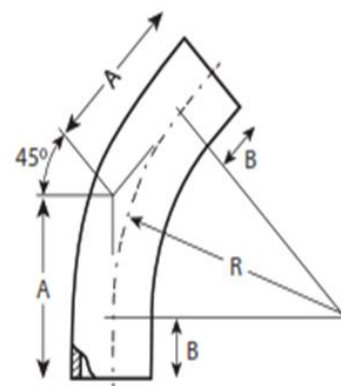

Address: Unit 12, 2nd Floor, No.2, Mofateh St, Nojumi St, Darvazeh Dolat St, Tehran, IRAN

Tel: +98 (21) 88 32 53 12

88 32 53 14

Fax: +98 (21) 88 32 53 15

Email: www.aabhayat.kala@gmail.com

Website: www.abhayatkala.com



30 Degree Sweep Bend

Size (mm)	A(mm)	B(mm)	R(mm)
20	130	100	100
25	130	100	100
32	134	100	128
40	140	100	160
50	146	100	175
63	160	100	225
75	230	150	305
90	230	150	305
110	280	180	380
125	280	180	380
140	320	200	460
160	320	200	460
200	320	250	535
225	400	250	535
250	460	300	615
280	510	350	615
315	605	400	715
355	710	500	780
400	830	550	1070
450	840	550	1100
500	1030	700	1250
560	1040	700	1280
630	1050	700	1315

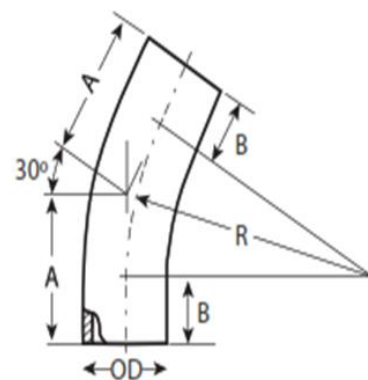

Address: Unit 12, 2nd Floor, No.2, Mofateh St, Nojumi St, Darvazeh Dolat St, Tehran, IRAN

Tel: +98 (21) 88 32 53 12

88 32 53 14

Fax: +98 (21) 88 32 53 15

Email: www.aabhayat.kala@gmail.com

Website: www.abhayatkala.com



90 Degree Segmented Bend (miter bend)

Normal size(mm)	Z _{min} (mm)	r(mm)	L _c (mm)
90	261	135	150
110	315	165	150
125	338	188	150
140	360	210	150
160	390	240	150
180	420	270	150
200	450	300	150
225	488	338	150
250	625	375	250
280	670	420	250
315	773	473	300
355	833	533	300
400	900	600	300
450	975	675	300
500	1100	750	350
560	1190	840	350
630	1295	945	350
710	1415	1065	350
800	1550	1200	350
900	1750	1350	400
1000	1900	1500	400

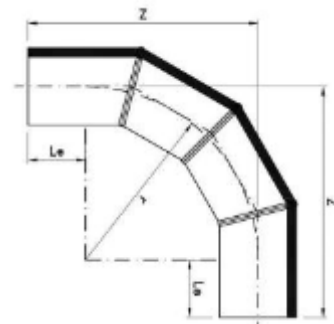

Address: Unit 12, 2nd Floor, No.2, Mofateh St, Nojumi St, Darvazeh Dolat St, Tehran, IRAN

Tel: +98 (21) 88 32 53 12

88 32 53 14

Fax: +98 (21) 88 32 53 15

Email: www.aabhayat.kala@gmail.com

Website: www.abhayatkala.com



60, 45 Degree Segmented Bend (miter bend)

Normal size(mm)	Z _{min} (mm)		r(mm)	L _c (mm)
	45°	60°		
90	189	207	165	150
110	218	245	165	150
125	228	258	188	150
140	237	271	210	150
160	249	288	240	150
180	262	305	270	150
200	274	323	300	150
225	290	345	338	150
250	412	466	375	250
280	424	492	420	250
315	498	576	473	300
355	520	606	533	300
400	548	646	600	300
450	580	689	675	300
500	665	783	750	350
560	698	835	840	350
630	741	896	945	350
710	792	695	1065	350
800	847	1043	1200	350
900	960	1179	1350	400
1000	1022	1266	1500	400

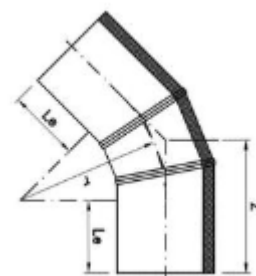

Address: Unit 12, 2nd Floor, No.2, Mofateh St, Nojumi St, Darvazeh Dolat St, Tehran, IRAN

Tel: +98 (21) 88 32 53 12

88 32 53 14

Fax: +98 (21) 88 32 53 15

Email: www.aabhayat.kala@gmail.com

Website: www.abhayatkala.com

